

## STATUS OF THE LASER STRIPPING OF H<sup>-</sup> BEAM AT J-PARC RCS

P.K. Saha<sup>\*,A</sup>, H. Harada<sup>A</sup>, H. Yoneda<sup>B</sup>, Y. Michine<sup>B</sup>, A. Sato<sup>C</sup>, T. Shibata<sup>D</sup>, M. Kinsho<sup>A</sup>

<sup>A</sup> J-PARC Center, KEK and JAEA, Tokai-mura, Ibaraki, Japan

<sup>B</sup> Univ. of Electro-Communications, Tokyo 182-1112, Japan

<sup>C</sup> NAT, Tokai-mura, Ibaraki 319-1112, Japan

<sup>D</sup> KEK, Tsukuba, Ibaraki 305-0801, Japan

### Abstract

To overcome the realistic issues and limitations associated with a stripper foil used for H<sup>-</sup> charge-exchange injection (CEI) at proton accelerators for high-intensity beam, we are studying a foil-less H<sup>-</sup> CEI by using only lasers. To establish our principle, a POP (proof-of-principle) demonstration of 400 MeV H<sup>-</sup> stripping to proton by using lasers is under preparation at the Rapid Cycling Synchrotron of Japan Proton Accelerator Research Complex. The H<sup>-</sup> is neutralized to H<sup>0</sup> first by stripping its loosely bound electron. The H<sup>0</sup> is excited by a deep UV laser before stripping it to proton by the same YAG laser. A prototype YAG laser system has been developed through experimental studies of 3 MeV H<sup>-</sup> neutralization. A multi-reflection YAG laser cavity system has also been developed and tested at 3 MeV. The installation of the YAG laser system at 400 MeV beam line of J-PARC Linac including R&D of the UV laser are in progress to start the POP experimental studies in 2024.

### INTRODUCTION

The multi-turn charge-exchange injection of H<sup>-</sup> (negative hydrogen) by using a thin solid stripper foil is an effective way to achieve high-intensity proton beam [1–4]. However, a short and unexpected lifetime of the foil as well as the uncontrolled beam losses caused by foil scattering of the circulating beam during injection period and the corresponding high residual radiation are two serious issues, especially at high-intensity operation [5–7]. Although, remarkable progress has been made for producing stronger foils [8], but it is still hard to maintain reliable and longer lifetime due to overheating of the foil at high-intensity [9], and it is one of the big concern to realize next generation multi-MW proton accelerators.

Laser manipulations of the H<sup>-</sup> beam by single or double neutralization is a very promising technique and highly essential to utilize in accelerator process, such as beam diagnostics, collimation, extraction and pulse chopping as well as stripping for the present and future high-intensity proton accelerators. To overcome the realistic issues and practical limitations associated with a stripper foil, a foil-less H<sup>-</sup> charge-exchange injection by using only lasers is under studied at J-PARC [10]. To establish the method, a POP (proof-of-principle) demonstration of 400 MeV H<sup>-</sup> stripping to proton by using only lasers is under preparation [11–13]. Figure 1 shows a schematic view of our present concept. The H<sup>-</sup> is first neutralized to H<sup>0</sup> by removing its outer most

electron by an YAG laser of 1064 nm. The ground state (1s) electron in the H<sup>0</sup> is excited to 3rd excited state (3p) named H<sup>0\*</sup> by using a deep UV laser of 213 nm, and finally the H<sup>0\*</sup> is stripped to proton (p) by removing the excited electron from the H<sup>0\*</sup> by using the YAG laser. A prototype YAG laser system and also a completely new type of multi-reflection cavity have been developed and step by step further developments are continued for higher energy, robust uses, reliability and long term stability through experimental studies of 3 MeV H<sup>-</sup> neutralization at J-PARC RFQ test facility (RFQ-TF) [14].

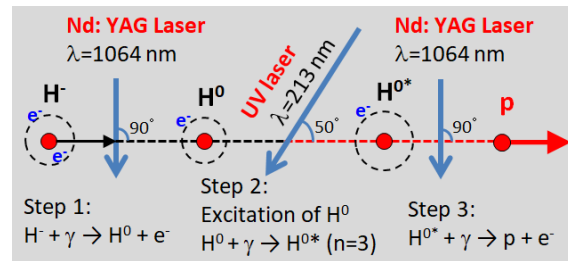

Figure 1: A schematic view of the principle of H<sup>-</sup> stripping to proton by using only lasers. Noted parameters are for an H<sup>-</sup> stripping at 400 MeV.

### THE YAG LASER AND MULTI-REFLECTION CAVITY SYSTEMS

Figure 2 shows a layout the prototype YAG laser system [13]. To start with, a combination of Arbitrary Wave Generator (AWG) and Electro Optic Modulator is used to generate programmable short pulse at high quality and high repetition, which is then fed into multi stage fiber amplifier systems. The design repetition rate is same as the H<sup>-</sup> micro pulse frequency of 324 MHz, but at present it is set to 162 MHz mainly for clearly and uniquely identifying the interaction signal at a different frequency than that of the main beam and with a less background. The laser pulses are finally amplified by Laser diode for about several mJ/micro pulse (design). The laser output pulses are then transfer to the multi-reflection cavity system. The laser energy at the latest experiment was 150 mJ for a duration of about 40 μs. The micro pulse length was typically 100 psec (σ) with 0.023 mJ/pulse at 6.172 ns interval, corresponding to a frequency of 162 MHz.

A requirement of considerably higher laser energy/pulse is one of main difficulties of the laser stripping, while it is hard to handle a bigger laser system. To minimize the seed

\* saha.pranab@j-parc.jp

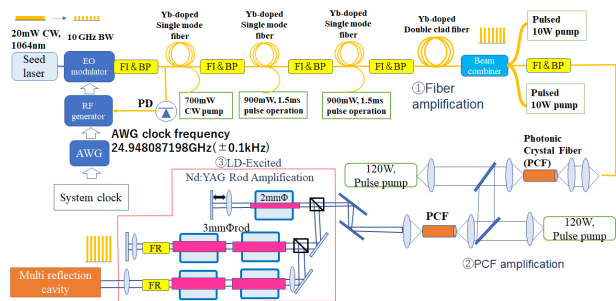

Figure 2: A schematic view of the YAG laser system developed for the POP demonstration, which was successfully tested for 3 MeV  $H^-$  neutralization.

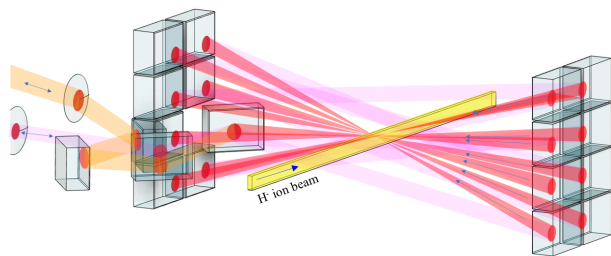

Figure 3: A schematic view of the 32 passes multi-reflection laser cavity system also tested for 3 MeV  $H^-$  neutralization.

laser energy, we have developed a multi-reflection YAG laser cavity system to overlap many laser pulses at the interaction point (IP). Figure 3 shows a schematic view of the final part of the cavity developed for 32 passes. This can essentially reduce the seeder power to  $\sim 1/32$  by considering negligible light losses at the optical devices and vacuum windows. A roof-top transverse tiny light image produced at the upstream of the cavity is transferred to the IP for maximizing the photon flux, while maximizing the spots at the mirrors to minimize their damage. A micro pulse energy of 0.023 mJ after 32 overlaps at the IP was obtained to be 0.38 mJ, nearly half than the number of passes, which was due to photon losses mainly at the vacuum windows ( $\sim 1\%$ /pass) as the cavity was placed outside the beam chamber. The laser system and the cavity were tested for 3 MeV  $H^-$  neutralization at the latest in 2022. We have also developed high efficient vacuum windows to achieve the loss rate less than 0.1%/pass, which will be tested in a near future experiment.

## EXPERIMENTAL RESULTS OF THE 3 MeV $H^-$ NEUTRALIZATION

Figure 4 shows the experimental setup for 3 MeV  $H^-$  neutralization at the RFQ-TF. The IP is set at the upstream of a bending magnet (BM). The  $H^-$  beam neutralized by the laser ( $H^- + \gamma = H^0 + e$ ) becomes neutral ( $H^0$ ), which is separated from the primary  $H^-$  by the BM. The  $H^-$  is deflected by the BM and goes to the 11-degree beam line and measured by a fast current transformer (FCT). The peak current of the  $H^-$  beam was 50 mA, same as for J-PARC Linac, where a macro pulse of  $50 \mu s$  was used.

Figure 5 shows an expanded view of the time domain signal of the FCT at the center of a  $50 \mu s$   $H^-$  macro pulse. A reduction of the pulse height at every alternate  $H^-$  pulses occurred due to a neutralization by a laser interaction. Figure 6 shows FFT spectra of the time domain signals of the FCT time domain data with laser ON and OFF depicted by the red and black lines, respectively. The FFT peak at 162 MHz appears only when the laser is ON, which was used for obtaining the neutralization fraction.

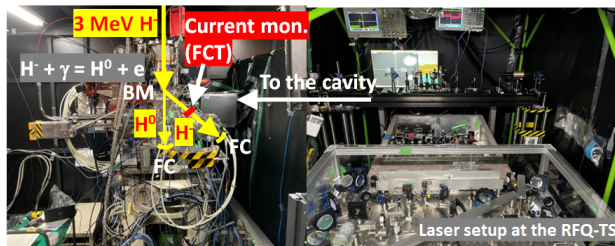

Figure 4: Setup of the laser system for 3 MeV  $H^-$  beam neutralization study at J-PARC RFQ-TF. The neutralization fraction is obtained by measuring the  $H^-$  signals with laser ON and OFF by the FCT.

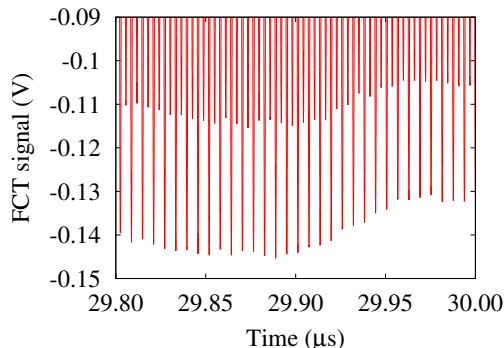

Figure 5: Expanded view of the  $H^-$  signal taken by the FCT. The neutralization occurs for every alternate  $H^-$  micro pulse.

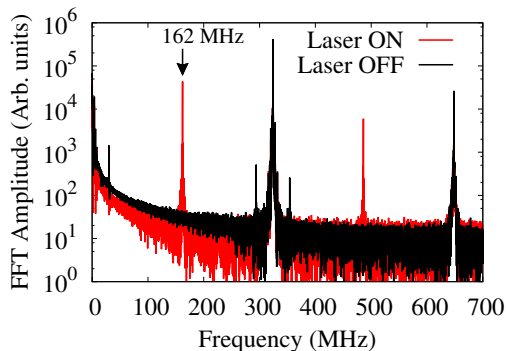

Figure 6: FFT spectra of the FCT time domain signals with laser ON (red) and OFF (black). The peak at 162 MHz with laser ON corresponds to a neutralization signal.

The neutralization fraction for every  $2 \mu s$  was calculated as shown in Fig. 7. The AWG waveform was carefully tuned

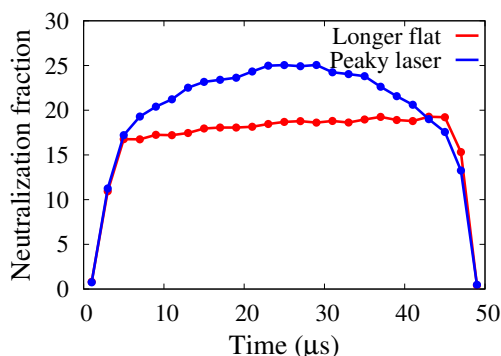

Figure 7: Time dependent neutralization over the entire H<sup>-</sup> macro pulse. A uniform neutralization throughout the H<sup>-</sup> pulse has been obtained. A further higher efficiency at the central part has also been obtained by using a peaky laser pulse.

with a precision better than  $10^{-3}$  GHz for a precise micro pulse frequency of the light pulse to obtain a flat neutralization of 18% over the entire H<sup>-</sup> macro pulse (red), while by using a further peaky laser pulse, a higher neutralization fraction of 25% around the middle of the H<sup>-</sup> macro pulse was obtained as depicted by the blue color. We also calculated the neutralization of individual micro pulses (Fig. 5) by integrating and comparing with neighboring un-neutralized pulse, which was also consistent with the FFT analysis results. Figure 8 shows the pass number dependence laser energy gain and the corresponding neutralization. The present result demonstrates the merit of the cavity to increase the laser pulse energy at the IP by reducing the seeder energy. We obtained a 1/16 reduction of the seeder energy at present, which was due to significant photon losses at vacuum windows, but it can be reached to  $\sim 1/32$  in the next trial by replacing with newly developed windows with higher efficiency coating as presented in the next section.

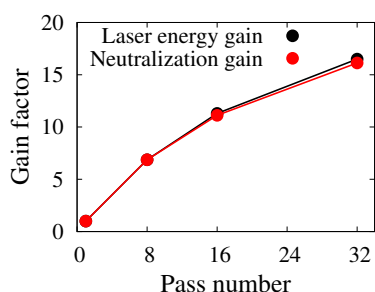

Figure 8: Comparison of the pass dependent laser energy gain and the corresponding neutralization gain.

## DEVELOPMENT OF HIGH-REFLECTIVE VACUUM WINDOW

To realize perfect benefit of the cavity system, the photon losses, especially at the vacuum windows have to be minimized. We have developed vacuum windows with high efficient coating for the YAG laser by which the photon loss can be reduced to more than one order of magnitude as com-

pared to the present windows used so far. Figure 9 shows the estimated pass dependent laser energy drop with 1% and 0.1% photon losses at vacuum windows at present (red) and newly developed higher efficient windows (blue), respectively. A photon loss of 75% can be reduced to at least 10% by using the new windows. As a result, a micro pulse energy of only 0.023 mJ from the present seed laser would give more than 0.67 mJ at IP with 32 reflections at the IP as compared to 0.38 mJ at present. Figure 10 shows an estimated neutralization as a function of the seeded pulse energy [15, 16]. At present with 1% photon loss/pass at the vacuum windows gives 18% neutralization (red) for 0.023 mJ/pulse from the seeder (0.38 mJ at the IP), but it can be increased to 30% (blue) by minimizing the window losses to 0.1%. Then, a seeder micro pulse energy of only 0.15 mJ will give us a more than 4 mJ energy at the IP to obtain a more than 90% neutralization. It is worth mentioning that we also plan to further double the number of reflections to 64. As a result, the seeder pulse energy can be further reduced as well as a higher neutralization can be achieved. Such a reduction of the seeder energy is more useful for the UV laser as a higher energy is required for the H<sup>0</sup> excitation as well as difficulties to handling such a deep UV laser with a higher pulse energy. A reduction of the seeder pulse energy is thus very effective to reduce average power of the seed laser to cover the whole injection period.

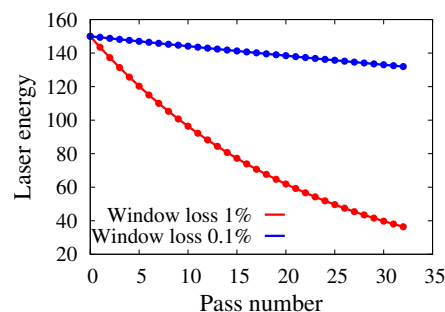

Figure 9: Estimated pass dependent laser energy drop due to photon loss at vacuum windows at present (red) and with newly developed higher efficiency ones.

## PREPARATION STATUS OF THE POP TEST AT 400 MeV

Figure 11 shows a schematic view of laser transport line setup for the 400 MeV POP test at the L-3BT. The main laser system will be installed at the power supply (PS) room of the L-3BT magnets, which is outside the accelerator tunnel and located at the 2nd floor. The laser will be guided from there to the POP chamber (already installed) at the downstream of the L-3BT by using separate vacuum pipes for the YAG and UV lasers. The total length from the laser main station to the POP chamber is about 70 m. This year the laser transport system installation at the upstream part (shown by the red line), which is from the laser main station (L-3BT PS room) to the sub station set at the L-3BT utility tunnel will be



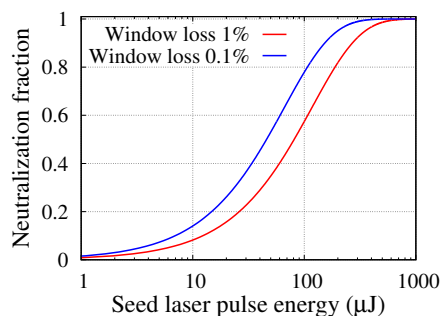

Figure 10: Estimated seeder pulse energy versus neutralization for two cases of photon losses at vacuum windows. A seeder pulse energy of only 0.015 mJ gives more than 4 mJ at the IP after 32 reflections with using newly developed vacuum windows to obtain a more than 90% neutralization fraction as shown by the red line.

completed. The laser transport vacuum pipes from the utility tunnel to near the POP chamber, which is about 40 m (shown by the yellow arrow) have already been completed and tested for the laser alignment and stability by using a green laser. The R&D of the UV laser as well as optical devices to handle such a deep UV laser have also been started through close collaboration with the manufacturer. Similar to the YAG laser, we will also develop a UV laser cavity system to minimize the seeder pulse energy. The 1st stage of POP demonstration of 400 MeV  $H^-$  laser stripping has been scheduled to start in 2024. It is also worth mentioning that we have demonstrated non-destructive measurement of both longitudinal and transverse beam profiles of the  $H^-$  beam at 3 MeV by laser manipulation, which can be easily implemented at 400 MeV and as an online monitoring during beam operation.

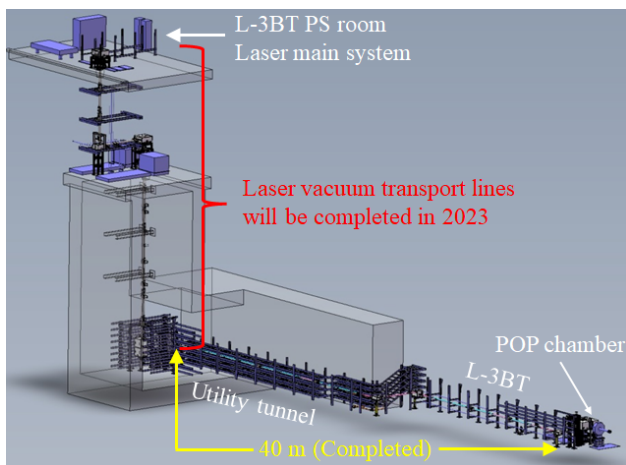

Figure 11: Schematic view of the installation of laser vacuum transport lines at the L-3BT through the utility tunnel. The upstream part (red) will be completed in 2023, where the yellow part has already been completed in 2022. The POP chamber has also been installed.

## SUMMARY

To replace the carbon foil used for the conventional  $H^-$  charge-exchange injection (CEI), a foil-less  $H^-$  CEI by using only lasers is under study at J-PARC. To establish the method a POP demonstration of 400 MeV  $H^-$  stripping to proton by using only lasers will be carried out. A prototype YAG laser system including a multi-reflection laser cavity system to significantly reduce the seed laser power have been developed and tested for 3 MeV  $H^-$  neutralization at J-PARC RFQ-TF. A maximum neutralization of 25% has been obtained by 0.38 mJ energy at the IP with 32 passes of only 0.023 mJ micro pulse energy from the seeder. A reduction of the seeder was 1/16 at present due to photon losses at the vacuum windows, but it can be reached to  $\sim 1/32$  by replacing the vacuum windows with newly developed higher efficient ones. As a result, the present seeder micro pulse energy of only 0.015 mJ will give more than 4 mJ at the IP to obtain a more than 90% neutralization. In addition, we will also upgrade the cavity system to double the reflections. Such a reduction of the seeder energy is more useful for the UV laser. The R&D of the UV laser produced by higher harmonic generation from the YAG laser is also in progress. The POP experimental studies for 400 MeV  $H^-$  stripping to proton will be started in 2024. We will first study the neutralization and non-destructive beam diagnostics of the 400 MeV  $H^-$  beam by a laser manipulation.

## ACKNOWLEDGMENTS

The authors would like to acknowledge our J-PARC colleagues for continuous support and cooperation in the present research. This work was partly supported by the JSPS KAKENHI Grant Number JP20H04456, JAEA HOUGA research funds (2017-2018, 2019-2020) including US-Japan collaboration for high-power neutrino beams.

## REFERENCES

- [1] High-intensity Proton Accelerator Project Team, "Accelerator Technical Design Report for J-PARC", JAERI-Tech 2003-044 and KEK Report 2002-13.
- [2] J. Wei *et al.*, "Low-loss design for the high-intensity accumulator ring of the Spallation Neutron Source", *Phys. Rev. Accel. Beams*, vol. 3, p. 080101, 2000.
- [3] H. Hotchi *et al.*, "RECENT PROGRESS OF 1-MW BEAM TUNING IN THE J-PARC 3-GeV RCS", *Proc. of IPAC'16*, Busan, Korea, 2016, paper MOPOR004, p. 592.
- [4] S.M. Cousineau *et al.*, "A FIFTEEN YEAR PERSPECTIVE ON THE DESIGN AND PERFORMANCE OF THE SNS ACCELERATOR", *Proc. of HB'16*, Malmo, Sweden, 2016, paper MOAM4P40, p. 9.
- [5] M.A. Plum *et al.*, "Stripper foil failure modes and cures at the Oak Ridge Spallation Neutron Source", *Phys. Rev. Accel. Beams*, vol. 14, p. 030102, 2011.
- [6] M. Yoshimoto *et al.*, "Radio-Activation Caused by Secondary Particles Due to Nuclear Reactions at the Stripper Foil in the J-PARC RCS", *Proc. of IPAC'17*, Copenhagen, Denmark, 2017, paper TUPVA093, p. 2300.

- [7] P.K. Saha *et al.*, “RECENT RESULTS OF BEAM LOSS MITIGATION AND EXTREMELY LOW BEAM LOSS OPERATION OF J-PARC RCS”, *Proc. of IPAC’22*, Bangkok, Thailand, 2022, paper WEOYGD1, p. 1616.
- [8] I. Sugai *et al.*, “Development of thick hybrid-type carbon stripper foils with high durability at 1800 K for RCS of J-PARC”, *Nucl. Ins. and Meth. A*, vol. 590, p. 16, 2006.
- [9] P.K. Saha *et al.*, “ First measurement and online monitoring of the stripper foil thinning and pinhole formation to achieve a longer foil lifetime in high-intensity accelerators”, *Phys. Rev. Accel. Beams*, vol. 23, p. 082801, 2020.
- [10] Isao Yamane, Hiroyuki Harada, Saha Pranab and Shinichi Kato, *J. of Part. Acc. Soc. Japan* vol. 13, p.1 2016 (In Japanese).
- [11] P.K. Saha *et al.*, “ Status of Proof-of-Principle Demonstration of 400 MeV H<sup>-</sup> Stripping to Proton by Using Only Lasers at J-PARC”, *Proc. of HB’18*, Daejeon, Korea, 2018, paper THP1WC02, p. 422.
- [12] P.K. Saha *et al.*, “ Studies of Laser Power Reduction for the Laser Stripping of 400 MeV H<sup>-</sup> beam at J-PARC RCS”, *JPS Conf. Proc.*, vol. 33, p. 011025, 2021
- [13] H. Harada *et al.*, “Development of Laser System for Laser Stripping Injection”, *JPS Conf. Proc.*, vol. 33, p.011026, 2021
- [14] Y. Kondo *et al.*, “Upgrade of the 3-MeV LINAC for Testing of Accelerator Components at J-PARC”, *Proc. of IPAC’19*, Melbourne, Australia, 2019, paper MOPTS046, p. 960.
- [15] R.C. Connolly *et al.*, *Nucl. Inst. and Meth. A* 312, p. 415, 1992
- [16] David E. Johnson *et al.*, *Proc. of LINAC’16*, East Lansing, MI, USA, 2016, paper TH2A01, p. 710.