

HIGH POWER TEST OF COUPLER WITH CAPACITIVE COUPLING WINDOW

S. Kazakov, H. Matsumoto, K.Saito, T.Higo, T.Saeki, M.Sato, F.Furuta,

KEK, High Energy Accelerator Research Organization,
 1-1 Oho, Tsukuba -shi, Ibaraki-ken, 305-0801, Japan.

Abstract

New type of coupler with capacitive-coupling inner conductor is designed in KEK. This coupler has a module structure, which is convenient for mass-production, assembling and repairing. Four samples of couplers were made and two of them were tested at high power level. The main parameters of the couplers and test results are presented in this paper.

INTRODUCTION

International linear collider, ILC, is probably next main project for high energy accelerators. It is supposed that collider will be about 20km long and will contain several thousands of superconductive accelerator structures. Each structure has a coupler to input RF power. Besides of power feeding coupler separates vacuum of accelerator structure from outside systems. Part of coupler close to accelerating structure operates at liquid helium temperature, other part connected to power distribution system is located at room temperature. There are two dielectric RF windows for vacuum isolation. Superconductive accelerator cavity requires ultra-pure cleanness during assembling and it should be assembled in spatial clean rooms. Then vacuum sealed structure is placed in cryomodul of accelerator. It means that RF window should be assembled together with structure and be placed close to structure to be able to insert into cryomodul. Close window position means that it has low temperature during operation. If power distribution system is air filled, it requires second warm RF window. Two windows increase a reliability of coupler also. To decrease cryogenic heat load the coupler should has low ohmic loss and low thermal flow from room temperature part to low temperature one. All of these make coupler rather complicated. Because of big number the coupler part of total cost of ILC is noticeable. Impotent task is to make coupler simpler and cheaper. It seems we found interesting approach to use capacitive window as cold one. It allows dividing coupler in several modules, Fig.1. It is convenient for mass-production, assembling and repairing. Cold window becomes simpler [1].

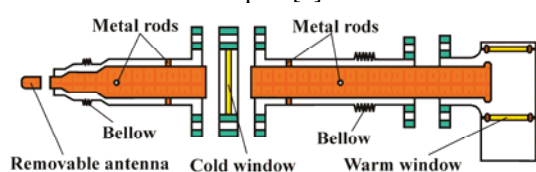

Figure 1: Module structure of coupler with capacitive coupling window.

DESIGN OF COUPLER

Goals of design were to construct a coupler with as low as possible electric field at dielectric RF windows, electric field in air part less than breakdown limit for full reflection from structure, to maximise passband keeping geometry as simple as possible. The same time coupler should be interchangeable with TTF-III coupler. Some design parameters of coupler presented in Table 1. Experimental samples of coupler were made by Toshiba Electron Tubes & Devices Corporation. Figure 2 shows assembled coupler. Figure 3 presents measured passband of single coupler.

Table 1: Design parameters of coupler

Frequency	1.3 GHz
Input	Waveguide, WR650
Output	Coaxial, D40mm x D17.4mm
Passband	70 MHz (SWR < 1.2)
Max. E- field ,cold window	11.5 kV/cm (500kW)
Max. E-field , warm window	5 kV/cm (500 kW)
Max. E-field, air	7 kV/cm (500kW)

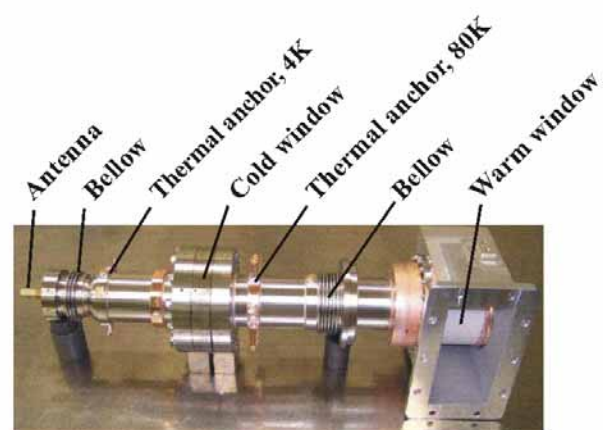

Figure 2: Assembled coupler.

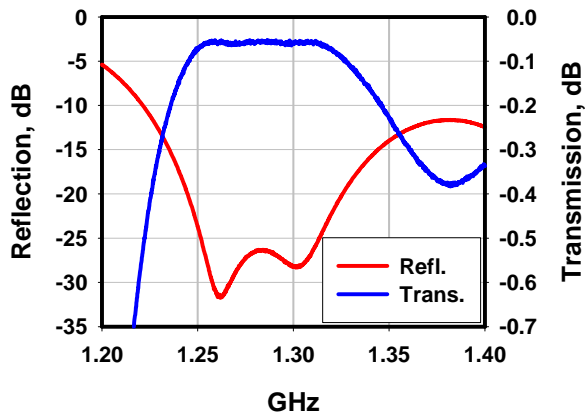

Figure 3: Measured passband of single coupler.

HIGH POWER TEST

Couplers were tested at high power level. The scheme of test stand is shown in Figure 4

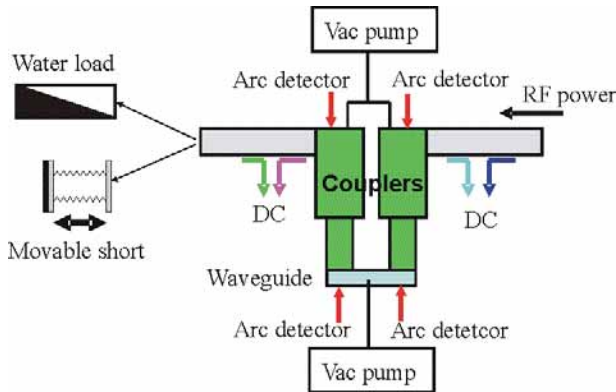

Figure 4: Scheme of high power test.



Figure 5: Photo of two couplers installed for high power test.

Figure 5 presents two couplers at high power test stand. It was made two test runs. During the first run couplers were tested without backing. After 20 hours of conditioning the power level was reached 2.3 MW x 1.7ms x 5pps. It corresponds to average power 19.6kW. The vacuum level was abbot 10^{-6} Torr. After short operation at this power level a warm window of one the coupler was broken by thermal stress. Loss tangent of present ceramic of warm window is 10-4. In future this ceramic will be replace with better one with loss tangent 10-5. We think it will increase the average power limit notably.

For the second run the broken warm window was replaces by new one. For this time the couplers were baked during 100 hours at 120C. The history of conditioning of second run is presented at Fig. 6. During 5 hours power was increased up to 1.2 MW and pulse length was extended to 1.5ms. Then couplers were kept at level 500kW x 1.5ms x 5pps for 8 hours. Then power was increased till 1.MW and coupler were kept at this level for 18 hours. After that power level was set as 2 MW, repetition rate was decrease till 3pps and couplers were kept at this pulse level for 3.5 hours. The vacuum pressure during second run was not higher then 10^{-7} Torr

As the next step the matching load was replaced by moveable short and coupler was tested at 500 kW x 1.5ms x 5pps at different short position. Trough this test, the couplers operated normally, RF were not destroyed

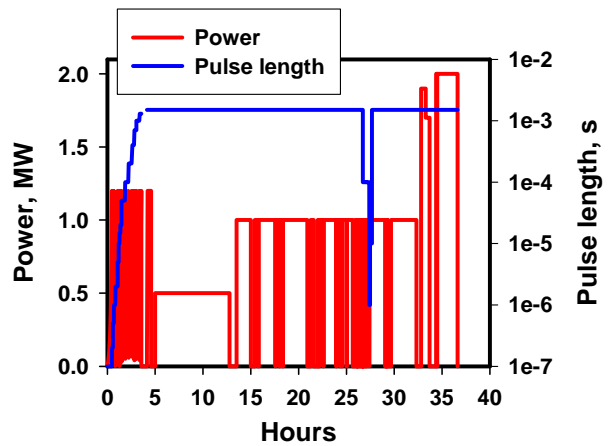

Figure 6: History of couplers conditioning.

At the time of second run the temperature was measured in several points of couplers including the surface of ceramic of warm windows. Figure 7 shows difference between temperature of warm window ceramic and input waveguide vs average input power during work for matched load. Curve is smooth. The nonlinear behavior we explain by different cooling condition of upper and bottom waveguide walls. Figure 8 shows the same temperature difference vs short position for 500 kW input pulse power working for short.

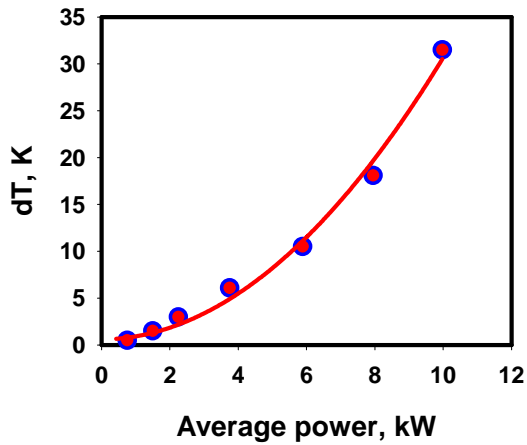

Figure 7: Temperature difference between warm window ceramic and input waveguide vs average power.

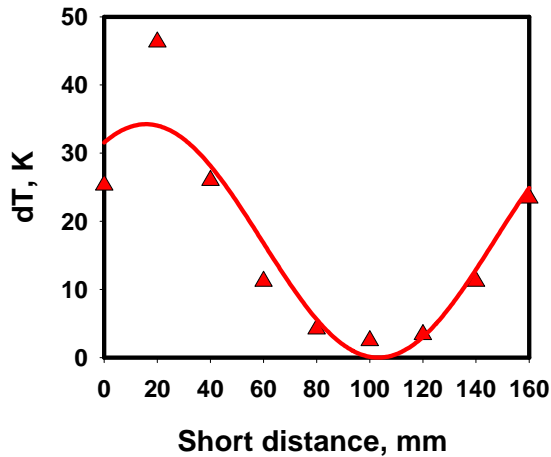

Figure 8: Temperature difference between warm window ceramic and input waveguide vs distance to short. Power is 500kW x 1.5ms x 5pps.

Multipactor

To suppress multipactor the most metal parts of coupler were coated by Ti and surfaces of ceramic window were coated by TiN. During the tests a multipactor effects were rather weak. In MP regime it appeared as vacuum change, slight change of shape of reflected signal was observed and it was not apparent at transmitted pulse. At power higher 200 kW there was no sign of multipactor. The pulse shape at the beginning of conditioning, multipactor regime is presented at Figure 9. Typical pulse shape after conditioning is in Figure 10.

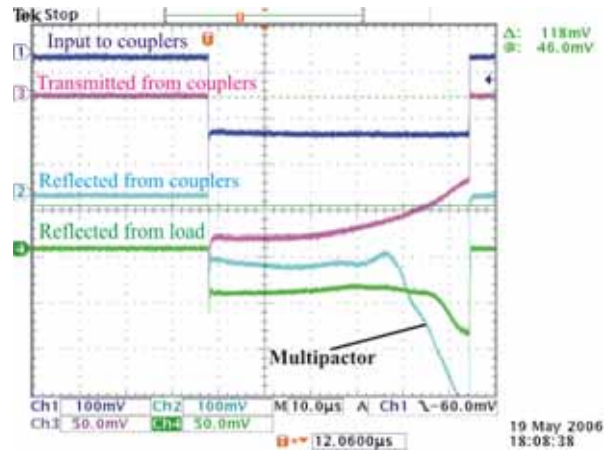

Figure 9: Pulse shape at the beginning of conditioning, multipactor regime.

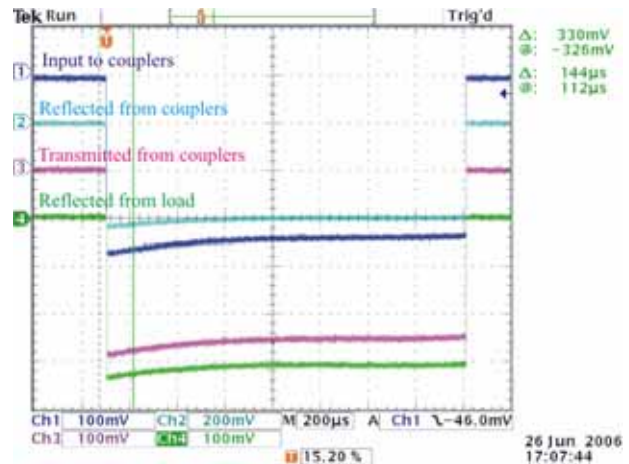

Figure 10: Pulse shape after conditioning, 2MW x 1.5ms x 3pps input pulse.

CONCLUSION

The experimental samples of L-band couplers with capacitive cold window for superconductive accelerator structure were made. Couplers were tested at high power level. Test demonstrated that couplers can successfully operate with pulse 1MW x 1.5 x 5pps and 2MW x 1.5ms x 3pps for matching load and pulse 500kW x 1.5ms x 5pps for short. Effect of multipactor is weak. Upper limit of multipactor is about 200 kW. These couplers are supposed to be used for STF in KEK.

REFERENCES

- [1] H. Matsumoto, S. Kazakov, K. Saito, "A New Design for Super-conducting Cavity Input Coupler", Proceedings of 2005 Particle Accelerator Conference, Knoxville, Tennessee, USA, May-2005, p. 4141